

# PRODUCT CATALOG

## Elevator Fixtures

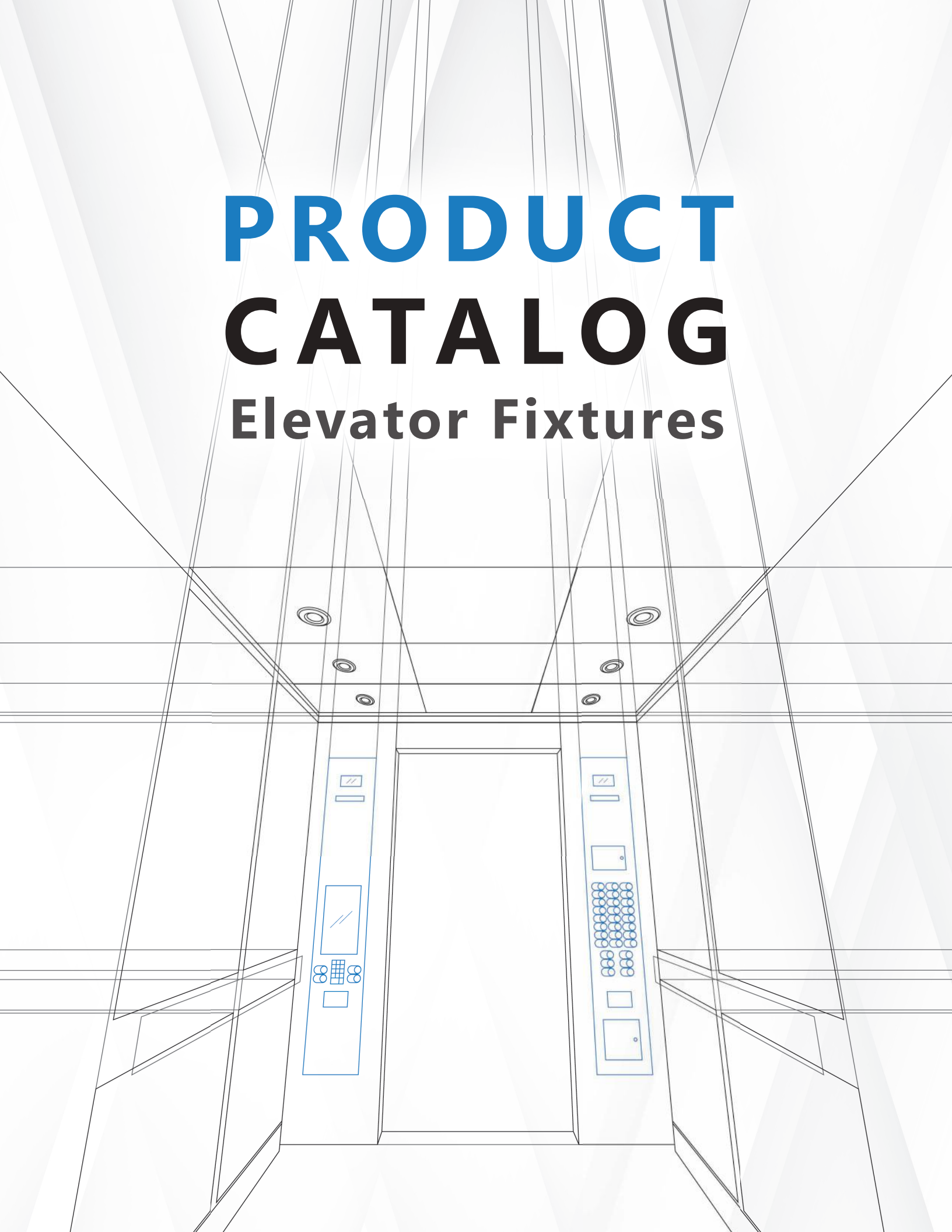

## **THE FIXTURES YOU SHOULD EXPECT**

Elevator fixtures have the biggest impact on your passengers' riding experience.

More than just an interface, fixtures have become an accent piece to the cab interior finish.

Don't settle on the ordinary... **expect more**

## **CAR OPERATING PANELS**

SAVOY COLLECTION	4
JULIUS COLLECTION	5
CAESAR COLLECTION	6
DUNE COLLECTION	7
COLOSSUS COLLECTION	8
CALIFORNIA COLLECTION	9
PLAZA COLLECTION	10
RITZ COLLECTION	11
GLASS	12
IMPULSE+	13
GILDA	14
CONCEPT	15

## **HALL FIXTURES**

HALL STATIONS	16
HALL LANTERNS	17
DESTINATION LANTERNS	18

## **DIGITAL TECHNOLOGY**

DESTINATION DISPATCH	19
MOSAIC - POSITION INDICATORS	20
ALTUS - LARGE FORMAT POSITION INDICATOR	21
TOUCH-TO-GO - TOUCHSCREENS	22
MosaicONE - MANAGEMENT SOFTWARE	24
VIDEO MESSAGING SYSTEM	26
MATISSE DIGITAL SIGNAGE	27
CONCIERGE - TWO WAY VIDEO COMMUNICATION	28

## **PUSHBUTTONS**

PUSHBUTTONS	30
-------------	----

# CAR OPERATING PANELS

## SAVOY COLLECTION

The Savoy Collection is an economical fixture solution encompassing the BL & BD pushbutton line.

With the Savoy Collection you can combine push button and Braille options to achieve the desired effect.



### OPTIONS

Illumination					
Tactile		Cast square brushed on black			
Upgrade		Any pushbutton style			
Plate Finish		Stainless Steel			



SS#4 COP shown with 4.3" Giotto TFT PI, BL Blank pushbutton, Cast square surface mount tactile, 2010 fire service upgrade provision and surface mounted switches.

# JULIUS COLLECTION

The Julius Collection offers a low-profile pushbutton and tactile / braille combination that is both attractive and cost-effective.

The lack of any hard edges combined with our positive stop pushbutton, makes the Julius Collection one of the most vandal-resistant products on the market.

Through a combination of different material finishes, pushbutton styles and LED illumination, the list of possibilities with the Julius is virtually endless.



## OPTIONS

Illumination



Red



Green



Blue



White

Tactile



Julius brushed on black with mirror surround

Upgrade



Any vandal round style pushbutton including BS Classic, Moon, California or BP Classic

Plate Finish



Available in #4, #8 Stainless Steel, #4, #8 Bronze and Oil Rubbed



SS#4 COP shown with 7" Giotto PI, BS classic pushbutton, Julius surface mount tactile and surround, 2010 code with a service cabinet.

# CAR OPERATING PANELS





## CAESAR COLLECTION

The Caesar Collection is the first of its kind in the elevator market, with illuminated tactile it will set your facility apart from all others in design and functionality.

Conceived as a solution to improve the floor button visibility (car operating panel) in poor ambient lighting conditions, the ADA compliant tactile character is illuminated 24/7.



### OPTIONS

Illumination		Red	Green	Blue	White
Tactile		Stainless Steel, PVD Bronze with blue, white or no illumination. Black with white illumination			
Upgrade		Any vandal round style pushbutton including BS Classic, Moon, California or BP Classic			
Plate Finish		Stainless Steel			



SS#4 COP shown with 10" Matisse TFT PI with custom graphics, BS Moon pushbutton, Caesar white illuminated tactile, 2010 code with service cabinet.

# DUNE COLLECTION

The Dune Collection is the offshoot of the Caesar Collection using a square vandal resistant pushbutton as opposed to round. The other identifying feature is the actual pushbutton face has a convex shape which gives it a very contemporary look and feel.

The Dune Collection makes for an ultra-attractive modern solution that will differentiate your facility from any other.



## OPTIONS

Illumination		Red    Green    Blue    White
Tactile		Stainless Steel, PVD Bronze with blue, white or no illumination. Black with white illumination
Upgrade		N/A
Plate Finish		Stainless Steel



SS#4 COP shown with 4.3 Giotto TFT PI with custom graphics, Dune pushbutton, non-illuminated tactile, 2010 code with service cabinet. Additional Features: Mirror and Stainless Inlay Work.

# CAR OPERATING PANELS

## COLOSSUS COLLECTION

The ultra-large pushbuttons from the Colossus Collection serve a unique application. The large surface area (or pressel) on the push button is easy to see and activate, which makes it very appealing to those individuals with impaired vision, tremors or like disabilities.

Typically the Colossus Collection is tailor-suited to public facilities, including but not limited to, airports, hospitals, and sporting venues.



### OPTIONS

Illumination



Red



Blue

Tactile



Slimline, Cast Square brushed on black

Upgrade



Not available

Plate Finish



Available in #4, #8 Stainless Steel



SS#4 COP shown with 7" Giotto TFT PI, Colossus pushbutton, slimline tactile, 2010 code with service cabinet.



# CALIFORNIA COLLECTION

Our fully code compliant California Collection features the Atoll button.

Like an Atoll, a ring-shaped coral reef that encircles a lagoon completely, the button is comprised of a stainless steel ring surrounding a plastic fully-illuminated bezel.

The California Panel has evolved as a trendy design sought out by architects and designers across the continent, not only to comply with code, but also to improve the aesthetic in the cab.



## OPTIONS

Illumination



White

Tactile



Flush Mounted Fishtail, white on black

Upgrade



Atoll

Plate Finish



Available in #4, #8 Stainless Steel  
#4, #8 Bronze and Oil Rubbed



SS#4 COP shown with 10" Matisse TFT PI with custom graphics, Atoll pushbutton, California Julius flush tactile, 2010 code with service cabinet.

# CAR OPERATING PANELS

## PLAZA COLLECTION

The Plaza Collection offers an elegant solution for facilities (hotels, condos, class A commercial) where a high number of floor call buttons are required in a relatively compact space.

While the Plaza Collection was conceived as a resolution to a unique issue (maintain ADA heights with high floors buildings) the aesthetic has caught on and is used in standard applications as well.

This design has proven very popular in the greater New York market.

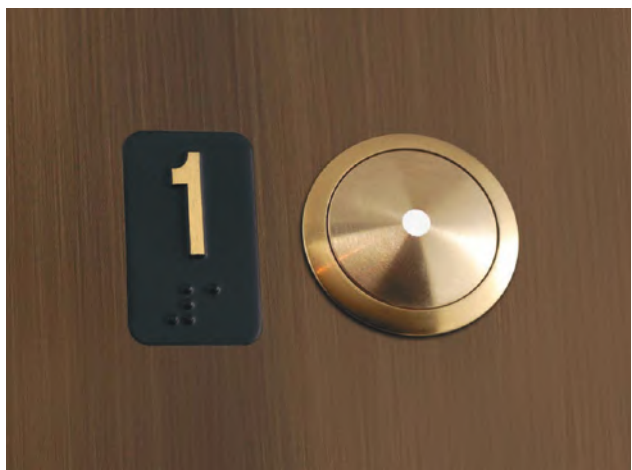

### OPTIONS

Illumination



Red



Green



Blue



White

Tactile



Slimline brushed on black

Upgrade



Any vandal round style pushbutton including BS Classic, Moon, California or BP Classic

Plate Finish



Available in #4, #8 Stainless Steel, #4, #8 Bronze and Oil Rubbed

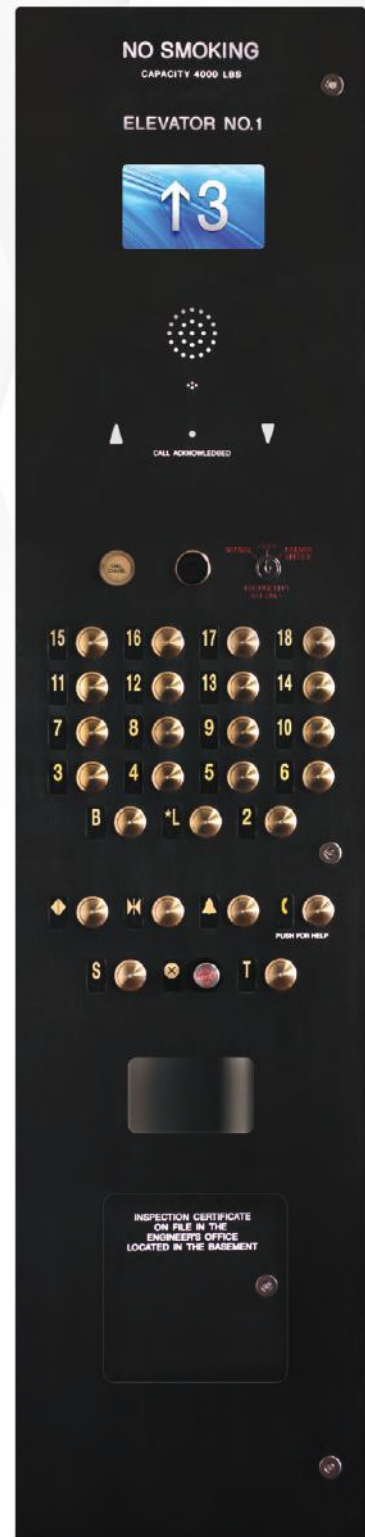

Oil Rubbed finish COP shown with 7" Giotto TFT PI, BP Classic pushbutton, Plaza Slimline flush mount tactile, Attendant Service, 2000 code with service cabinet. Additional Features: Flush Cam Lock and Card Reader Lens.

# RITZ COLLECTION

The Ritz Collection offers a nostalgic look to the elevator interior. By using an adjacent "pin-mount" tactile/Braille, the net effect is one of sheer elegance.

The appeal is largely accomplished via the overall look of the operating panel and the attention to detail that is inherent in its design. As each tactile character and each Braille pin is set individually in the car station, it has a craftsmanship quality that cannot be duplicated by other methods.



## OPTIONS

Illumination



Red



Green



Blue



White

Tactile



Pin Braille-mount mirror, brushed or hand painted silver, black or gold

Upgrade



Any vandal round style pushbutton including BS Classic, Moon, California or BP Classic

Plate Finish



Available in #4, #8 Stainless Steel, #4, #8 Bronze and Oil Rubbed



Bronze #4 COP with 7" Matisse TFT PI with custom graphics, BS Moon pushbutton, Ritz pin mount tactile, 2010 service code with service cabinet.

# CAR OPERATING PANELS

## GLASS

Contemporary glass fixtures are becoming a popular alternative to traditional Stainless Steel car panels. Finally builders, architects and interior designers can bring the building's design not only into the elevator interior, but into the fixtures as well.

Our new prestigious Glass fixture line ties the modern and innovative concepts together. Its sleek look and functionality will be a great accent for your newly refreshed elevator interior.



### OPTIONS

Illumination



Red



Green



Blue



White

Tactile



Stainless steel with white, no illumination or cast brushed on black

Upgrade



Standard or California Dune pushbutton

Plate Finish



Available in any colour or desired print in background



Custom back-painted code compliant glass, with 10" Matisse TFT PI with custom graphics, Dune pushbutton and surround, 2010 code with service cabinet

# CAR OPERATING PANELS (RETROFIT KIT)

## IMPULSE+

The Impulse retrofit kit is designed for the Dover Impulse elevator fixture.

A direct retrofit replacement means no dimensions or measurements to worry about, no cutting or complex installation methods.

The end result is a quick installation that minimizes your elevators down time, while upgrading your fixture to a more reliable vandal proof design.

The Impulse+ Retrofit offers a turn key solution while improving the elevator's reliability.

### OPTIONS

Buttons/Tactile All buttons/Braille tactiles available

Plate Finish All materials and finishes available

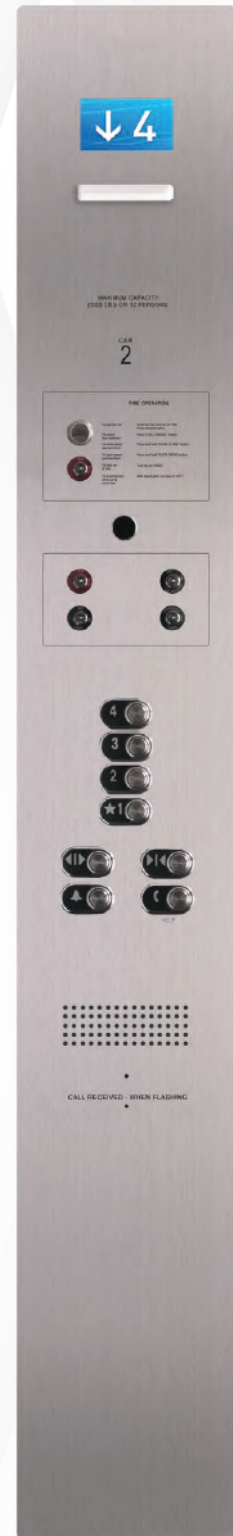

SS#4 COP shown with 7" Giotto TFT PI, BS Classic pushbutton, Julius surface mount tactile and surround, 2000 code with surface mount service key switches.

# CAR OPERATING PANELS (MODERNIZATION KIT)

## GILDA

The Gilda Surface Mount Panel is a bold initiative and revolutionary concept that allows building owners to upgrade their elevator fixtures faster while minimizing down time.

The 15/16" deep car station can be manufactured at varying widths and lengths to accommodate whatever site conditions might exist.

The most salient feature of the Gilda is that there is no need to enlarge the car station opening in order to accommodate the new unit.

In a climate of escalating labor costs and shorter lead times, the Gilda Surface Mount Panel offers a real world solution.

### OPTIONS

Buttons/Tactile All buttons/Braille tactiles available

Plate Finish All materials and finishes available

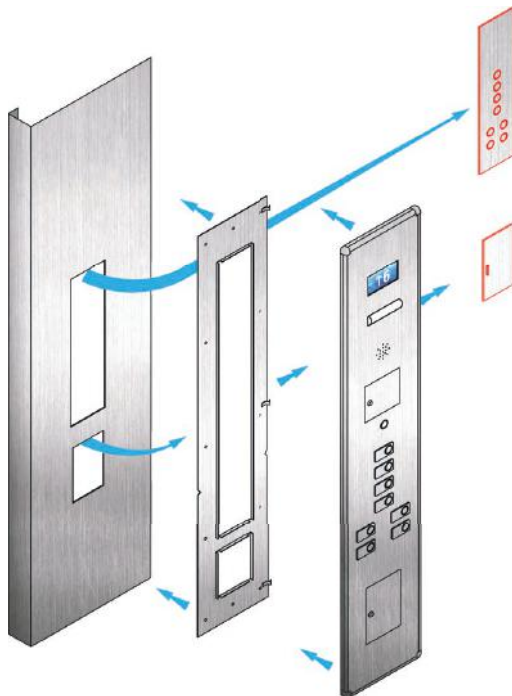

SS#4 COP with 7" Matisse TFT PI, BS Classic pushbutton, Julius surface mount tactile and surround, 2010 code with service cabinet. Additional features: flush mount parking levels color plates.

# CAR OPERATING PANELS (CONCEPTUAL DESIGN)





## CONCEPT

If you can envision it,  
we can build it.

Our team of engineers and designers are always looking for a new challenge. Making a custom design and materializing the idea is what defines who we are.



### OPTIONS

Illumination		Anything
Tactile		Anything
Upgrade		Anything
Plate Finish		Anything



Agglomerated Marble COP shown with 19" custom panoramic TFT PI, Julius surface mount tactile and surround, 2000 code.

# HALL FIXTURES

## HALL STATIONS

Our Hall Station collection is crafted with a quality that cannot be replicated. With numerous options we can match the look and feel of the building design and guarantee quality and compliance with the elevator and building code.

By offering a fully customizable experience we can provide different types of material such as stainless steel, bronze and glass with different mounting options.

Don't limit yourself, design the fixture your building deserves.



*Flush Mount Terminal*

### OPTIONS

Illumination



Red



Green



Blue



White

Buttons



Available with MAD pushbuttons

Fixture Type



Gilda Classic, Corner and Curve Surface Mounts, Flush, Concealed or Pan Shape.

Plate Finish



Available in #4, #8 Stainless Steel, #4, #8 Bronze, or Oil Rubbed.



Terminal Gilda Surface Mount Hall Station with Tri-Flame etching and fire service.



# HALL LANTERNS

Like our Hall Stations, we offer a fully customizable experience with our Hall Lanterns. We can provide different types of material such as stainless steel, bronze and glass along with various types of mounting options.

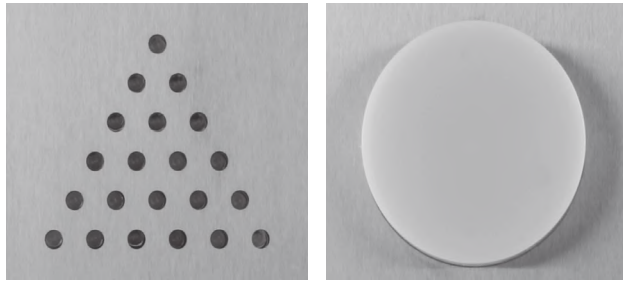

Left: Vandal Resistant Arrow, Right: Round Lens

## OPTIONS

Illumination



Red



Green



Blue



White

Arrow Type



SA-130, ADA, Round, Vandal Resistant Arrows, or Vision Series (Acrylic or Glass). Digital TFT position indicators can also be included

Fixture Type



Gilda Classic, Corner and Curve Surface Mounts, Flush, or Concealed Mounting

Plate Finish



Available in #4, #8 Stainless Steel, #4, #8 Bronze or Oil Rubbed.



Left: Flush mount hall lantern with ADA Mini Arrows. Right: Vision series hall lantern

The Machined Silk Cast Acrylic of the Vision Series Lanterns is an elegant solution for the modern day lobby. The glass aesthetic enhances the architectural finishes for the lobby and hall, while the bright LED illumination is easy to see in all ambient light conditions.

Custom lanterns available.



Gilda Classic hall lantern with ADA Arrows and Giotto 4.3" Position Indicator

# HALL FIXTURES

## DESTINATION LANTERNS

MAD offers a variety of Destination Lanterns to meet your project requirements. Choose between our Value Series, Standard series or Concept (custom) design. From a plate design to illuminated flag, we can match the design of your building. Puck replacement and Ray Blade lanterns also available.

### OPTIONS

Illumination



Red



Green



Blue



White

Fixture Type



Gilda Classic, Corner and Curve Surface Mounts, Flush, Concealed or Pan Shape.

Plate Finish



Available in #4, #8 Stainless Steel, #4, #8 Bronze, or Oil Rubbed.

Letter Type



Acrylic, Glass

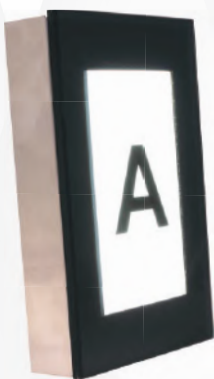

# DESTINATION DISPATCH

## DOOR-IN-DOOR SOLUTION



The Door-in-Door solution allows a single set of push buttons to be used for both fire and regular service. The inner door acts as the service cabinet providing access to both the button and service keyswitches, while the outer door provides additional access to the fire service controls.

## TOUCHSCREEN DESTINATION SOLUTION



Upgrade the Destination Dispatch COP with a Touch-To-Go touchscreen. While in DD mode, the TTG screen can act as a next-destination indicator, a digital signage board, or used for 2-way video communication. In independent or fire service mode, the graphics will automatically change, allowing the passenger to select destination floors and eliminating need for 'hidden' mechanical pushbuttons.



# POSITION INDICATORS



## MOSAIC

Redefine your elevator with a modern Position Indicator.

**Matisse:** The premium option available in the TFT designer's series. Featuring a fully networkable unit with widgets, news, two-way video capabilities and live video streaming. All screens are designed on the cloud (networked). It is available in 7" up to 21".

**Giotto:** The mid-range of the new TFT designer series with its multicolor graphic Position Indicator. Available in 4.3" & 7".

**Raffaello:** The micro version of the three balances both cost and functionality. Perfect for integrating Position Indicators in your hall fixtures design or lobby panels. Available in 2.8".

- ✓ High resolution & fully customizable graphics
- ✓ Integrated voice annunciator
- ✓ Two-Way video capable (Matisse)
- ✓ Programmable audio and video messages
- ✓ Self administration with easy-to-use Mosaic software



Available screen sizes listed above

# LARGE FORMAT POSITION INDICATOR

## ALTUS

Combining the Mosaic Position Indicators, Matisse Digital Signage, and per floor messaging of Touch-To-Go, the Altus is large enough to take advantage of all the functionality in one. Available in 19", 28", 38" and 48". Can be positioned landscape or portrait.



- ✓ Remote admin and updateability
- ✓ Fully customizable
- ✓ Time, weather, social media, news (RSS feeds), videos, photos, and HTML content
- ✓ 'This Floor' and 'Next Stop' interactive messages
- ✓ Live video input & two way video capable
- ✓ Digital signage

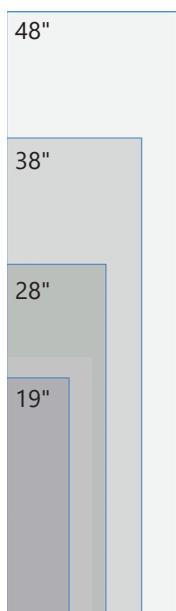

Custom sizes available.

Standard sizes listed above.



SS#4 COP shown with 48" Altus PI, Dune pushbutton and Surround with Cast Tactile

# TOUCHSCREEN COP SOLUTION

## TOUCH-TO-GO

Using vibrant, easy-to-read, color touchscreens linked to a custom control system, our elevator touchscreen systems create a distinctive experience that will have a high impact on the passenger and enhance the usability of the elevator.

- ✓ Interface with any elevator controller
- ✓ Remote admin and updateability
- ✓ 21" HD LED display with a viewing angle of 178 degrees
- ✓ Security system integration
- ✓ Vandal-resistant & code compliant
- ✓ Operated with finger-touch or with a gloved/covered hand
- ✓ Images, video, live video, live news ticker, weather and 2-way video capable
- ✓ Easy-to-clean surface with any glass approved solution

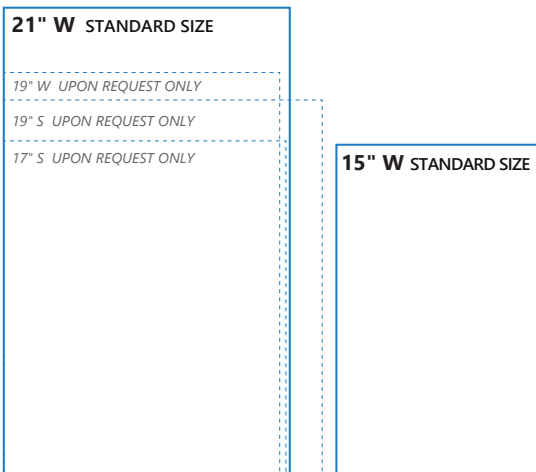

SS#4 COP shown with 10" Matisse PI, BS classic push button, Caesar surface mount non-illuminated tactile, ADA compliant key pad, 21" Touch To Go Touch Screen, 2010 service code with service cabinet.

**Upgrade your traditional pushbuttons.** Add a fully-interactive, customizable feature to your premium cab interior. Our unrivaled touchscreen allows for changes to graphics on an as-needed basis. User-defined areas available to update at any time via MosaicONE cloud-based management software.

## RESIDENTIAL & HOTEL

Brand your elevator and keep your residents and guests informed with message boards, which can be scheduled to automatically update. Change the displays for special occasions such as holidays or events.

Architectural renderings can be incorporated into the graphics to identify destination floors when selected.

Highlight building amenities and commonly used services such as pool, spa, or restaurants. Instructions can also be added to the screen (ex. scan access card).

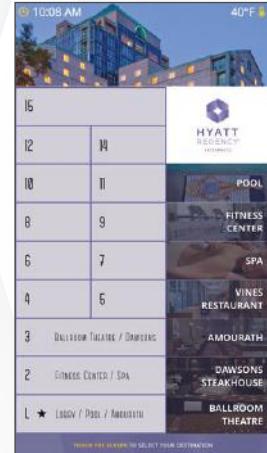

## HOSPITAL & AIRPORT

The smooth glass surface is easy-to-clean with any glass-approved solution. When Special Service is activated (such as Code Blue), graphics automatically change to a simplified layout, including instructions for passengers.

Colorful, high-contrast graphics and large touch areas make the screen easy-to-read and use in a for a variety of passengers, including in multi-lingual facilities. The wayfinding feature incorporates interactive maps of the facility for easy orientation.

Calls can be made by finger-touch or with a gloved/covered hand.



## UNIVERSITY & COMMERCIAL

Keep students up-to-date on Sports functions with live Twitter and news feeds.

Interactive informational pop-ups can offer more details to items of interest, such as upcoming campus events.

Providing tenant names and descriptions assures visitors that they are headed to the correct floor, while also promoting the corporate identity of each tenant and of the building.

Commercial jobs can include universities, malls, office buildings, stadiums, libraries, museums, and more.

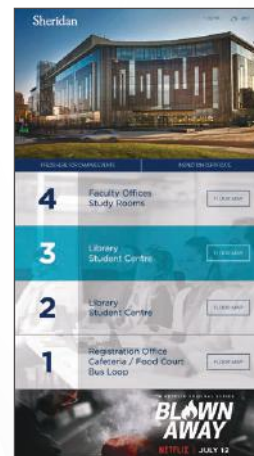

For more info, visit [madelevator.com](http://madelevator.com) or [touchtogo.ca](http://touchtogo.ca)

## Management Software

One software to manage all devices.

MosaicONE is a cloud-native software that allows a user from any location with an Internet connection to update and manage any of the networked devices from MAD.

The theme designer allows you to create or edit the displays whenever and wherever you want! You can do it all yourself, or delegate responsibility to other users.

- ✓ News, Stocks & RSS feeds
- ✓ Time & Weather
- ✓ Pictures & Video
- ✓ HTML Content
- ✓ Position Indicator
- ✓ Per Floor Messaging
- ✓ Fully Customizable

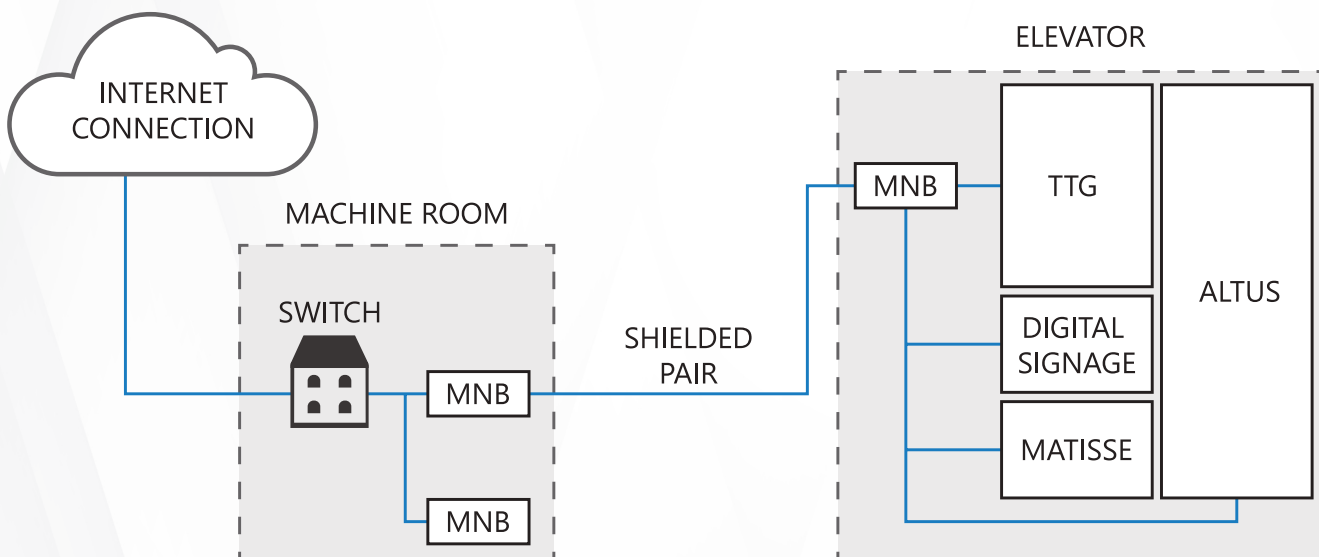
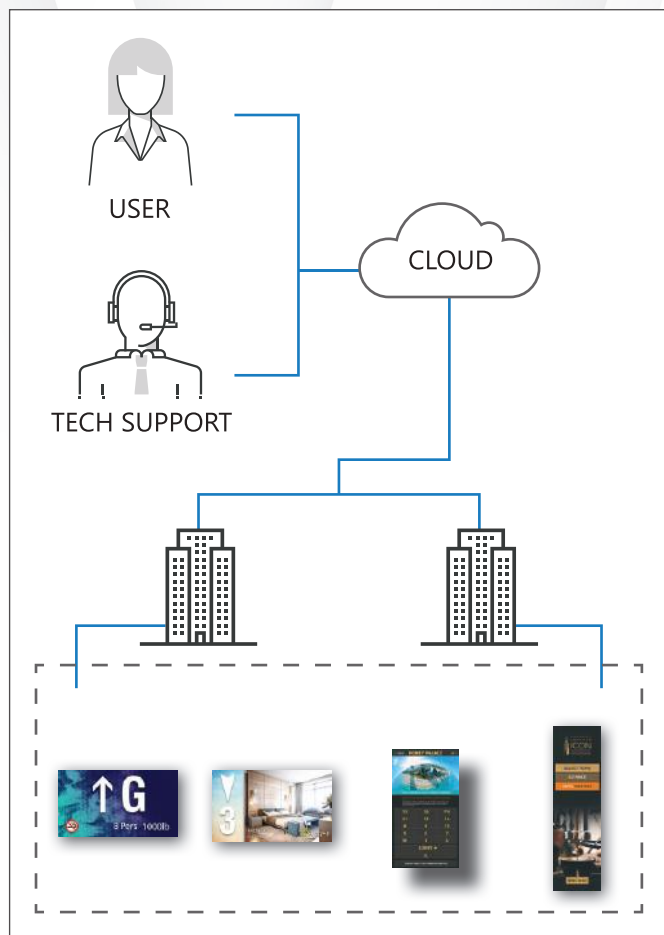

MNB = MAD Network Box



## WHAT CAN YOU EXPECT?

Manage all your devices from one browser login. With just a few clicks, schedule important notices days, weeks or months in advance for display at the assigned time on the appropriate day.

The easy-to-use platform enables you to create powerful digital signage using any type of content. Design, preview and publish your content from anywhere at any time. Notices can include events, directories, images, news feeds, weather, video, and more!

## SIMPLE AND CONVENIENT USER INTERFACE

The screenshot displays a digital signage management interface. At the top, a 'Content Widgets' bar is visible. The main workspace is divided into several sections:

- Content Area Menu (Left):** Lists various content types such as Position Indicator, News, Current weather, Forecast, Time, Date, Image gallery, Company logo, and Background.
- Content Editing Menu (Bottom Left):** Shows the current content being edited, 'mosaicone-screen-layout.jpg'.
- Content Widgets (Center):** A grid of widgets including:
  - PI Logo:** A large blue arrow pointing up with the number '2' below it.
  - Image Gallery News Reel:** A carousel of images featuring a roller coaster and a car.
  - Date Time Weather Forecast Current Weather:** A weather widget showing 'Jul 9, 2019', '3:47 PM', and a 5-day forecast.
- Area Properties Menu (Right):** A panel for configuring the background area, including fields for Name, Left, Top, Width, Height, Fill Colour, Border Colour, Border Thickness, Opacity, and Transition.
- Content Properties Menu (Bottom Right):** A panel for configuring the content widget, including fields for Size, Horizontal alignment, and Vertical alignment.

- ✓ Matisse
- ✓ Altus
- ✓ Touch To Go



## VIDEO & MESSAGING SYSTEM

The MosaicONE VMS is designed to meet the requirements of A17.1/B44-19 and modified IBC code. This system provides secure live video access to the inside of the elevator from remote monitoring stations and on-site personnel. In conjunction with the two-way messaging system (for communication with passengers with hearing or speech disabilities), any authorized personnel can quickly assess and address the situation.

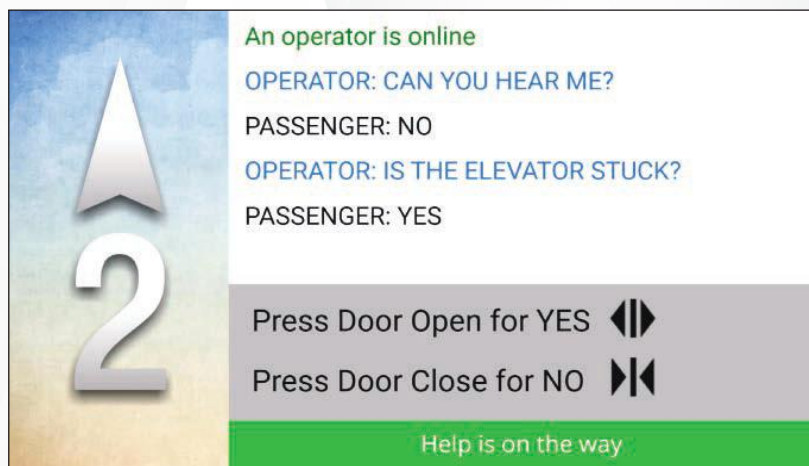

- ✓ A17.1/B44-19 and IBC 2018 code compliant
- ✓ Complete system; including 4 hour battery backup
- ✓ Live video of elevator interior
- ✓ Real-time two-way messaging
- ✓ Works with any elevator phone
- ✓ System access from local FCC panel and remote Monitoring Centers
- ✓ Closed firewall and encrypted communication
- ✓ MosaicONE Digital Signage included

Messages are posted in real-time on the lobby panel and elevator position indicator screen via MosaicONE Cloud. The operator has the ability to write a custom message, or select from prewritten messages. Passengers can message “Yes” or “No” responses back to operator via the Door Open & Close pushbuttons. Live encrypted video of elevator interior is available to the remote monitoring station, on-site personnel and fire control panel.

MosaicONE VMS comes as a complete system including camera, in-car screen, networking equipment, and battery backup. For more info, visit [madelevator.com/VMS](http://madelevator.com/VMS).

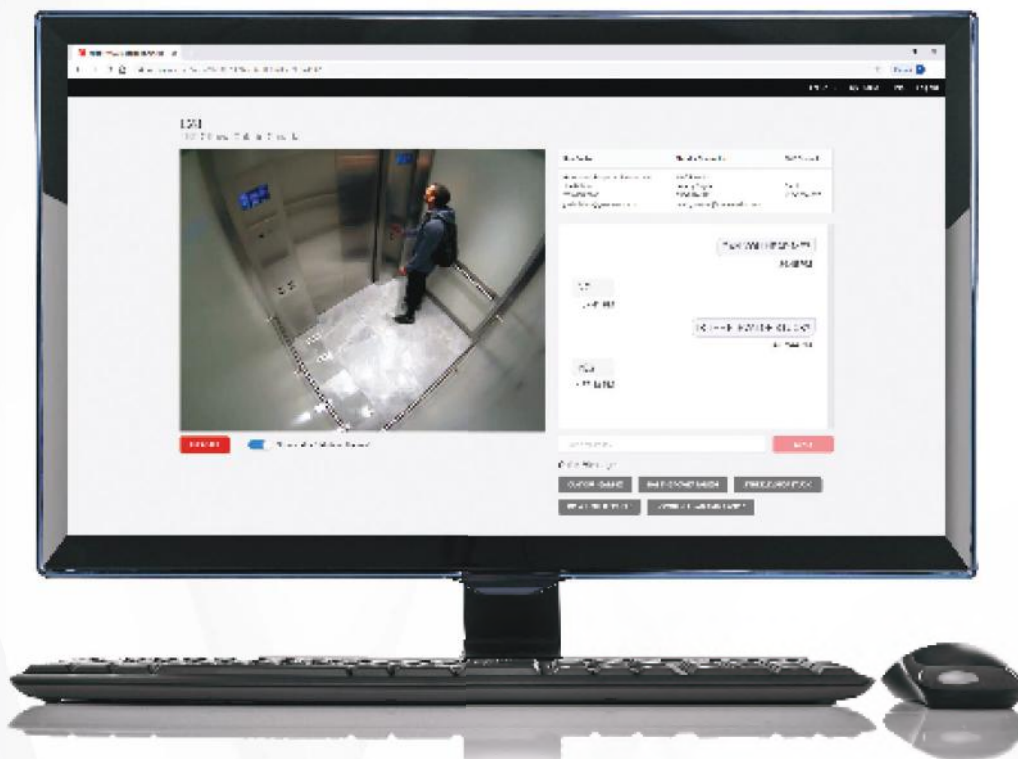

# DIGITAL SIGNAGE

The Matisse digital signage brings the elevator notice board into the 21st century. Using customized top-of-the-line LCD screens and software suites, the Matisse digital signage can suit virtually any foreseeable need.

Software: All Matisse come with MosaicONE software to create powerful digital signage for any content at anytime.

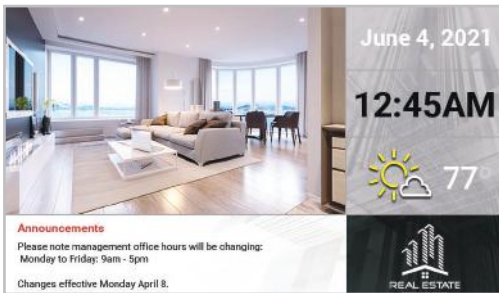

- ✓ Time & Weather
- ✓ News & RSS feeds
- ✓ Pictures & Videos
- ✓ Text (ex. notice boards)
- ✓ Scheduling
- ✓ HTML content
- ✓ Fully Customizable

Flush Mount available in: 10", 12.1", 15", 17", 19", & 21". Can be positioned landscape or portrait.

Surface Mount available in: 15"

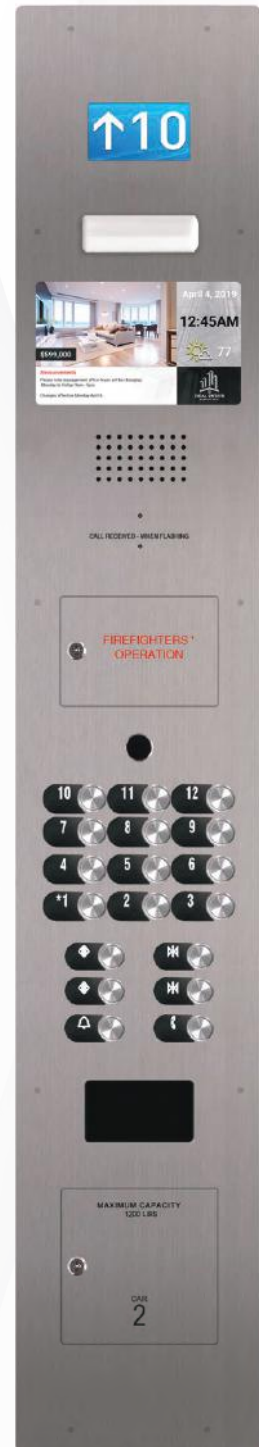

SS#4 COP shown with a 10" Matisse digital signage screen, 4.3" Giotto TFT PI, BS classic pushbutton, Julius surface mount tactile and surround, 2010 code with a service cabinet.

# TWO-WAY VIDEO COMMUNICATION

## TWO-WAY VIDEO COMMUNICATION

Our two-way video system allows the passenger to communicate with the Concierge/Security staff in the event of an emergency.

The elevator is equipped with a high resolution pin-hole camera. The Concierge/Security desk will have a panel where they can activate the camera and two-way video communication.

Integrable with the Matisse TFT display or Touch-To-Go touchscreen system.

- ✓ Fully customizable
- ✓ Live video
- ✓ High Definition
- ✓ Finger touch capability
- ✓ Integrable with the TFT Matisse display and Touch-To-Go touchscreen
- ✓ Highly recommended for buildings with hearing impaired passengers

## CONCIERGE SERVICE

*Advanced attendant service functionality. Offered as an additional feature.*

Concierge Service gives remote elevator control to the Concierge/Security desk. After the visitor is authorized, the Concierge/Security can dispatch the elevator to the desired floor.



SS#4 COP shown with 10" Matisse PI, BS classic pushbutton, Caesar surface mount non-illuminated tactile, ADA compliant key pad, 21" Touch To Go Touch Screen, 2010 service code with service cabinet.



The Concierge/Security can monitor inside of elevators via live video feeds and dispatch an elevator to the desired floor with advanced attendant service (*additional feature*)



After an emergency call is activated from within the elevator, the live video feed from that elevator automatically enlarges, allowing Concierge/Security to quickly see what is happening in the elevator.

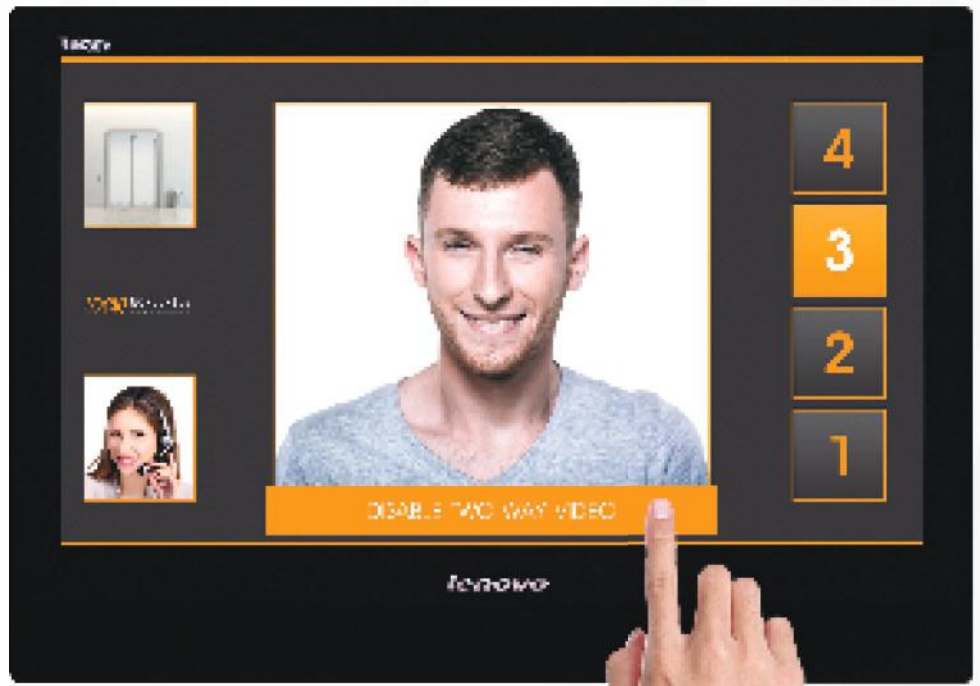

When Concierge/Security activates the two-way video, live video of the Security/Concierge is streamed into the elevator and displayed on either the Touch-To-Go touchscreen or Matisse TFT display.

# PUSH BUTTONS

	BS CLASSIC	BS MOON	BS CALIFORNIA	TOUCHLESS	BP CLASSIC
<b>SAVOY</b> SURFACE MOUNT SQUARE TACTILE					
<b>JULIUS</b> TACTILE AND SURROUND					
<b>CAESAR/DUNE</b> RETRO ILLUMINATION TACTILE					
<b>RITZ</b> PIN MOUNT TACTILE					
<b>ROUND</b> FLUSH					
<b>PLAZA</b> SLIMLINE TACTILE					
<b>JULIUS</b> FLUSH					
<b>SQUARE</b> FLUSH					
<b>BAR BUTTON</b> TACTILE AND SURROUND					

DUNE

ATOLL

BL BLANK

BL/BD SYMBOL

COLOSSUS

		NOT RECOMMENDED	NOT RECOMMENDED	NOT AVAILABLE
		NOT RECOMMENDED	NOT RECOMMENDED	NOT AVAILABLE
		NOT RECOMMENDED	NOT RECOMMENDED	NOT RECOMMENDED
				NOT RECOMMENDED
NOT AVAILABLE				NOT AVAILABLE



Etched Bar Button with custom font

Blank Bar Button



1806 S. Lake Stevens Rd.  
Lake Stevens, WA  
98258

1 (888) 277-8310  
[www.liftsolutions.net](http://www.liftsolutions.net)  
[info@liftsolutions.net](mailto:info@liftsolutions.net)

This publication is for general informational purposes only. Product design is subject to change without notice. Actual product colors, finishes and specifications may vary from graphical representations.

Presented by Lift Solutions, Inc. on behalf of MAD Elevator Inc.

Copyright © 2019 MAD Elevator Inc.

Ver 5.3